

# Development and Mass-Production of the New “Proadlizer” Decoupling Device

TAKAHASHI Kenichi, INOUE Takeo, NAGASAWA Toshihisa, SEKIGUCHI Yoshinori

## Abstract

The Proadlizer is an epoch-making decoupling device that can match market requirements for both the present and future. Its low-impedance and flat frequency response over the wide frequency range of from some tens of kHz to a few GHz and it also offers high capacitance. This paper is intended to describe its features, construction, characteristics, reliability and its mass-production and series production methods.

## Keywords

large capacitance, low impedance, high frequency, decoupling

## 1. Introduction

The trends of the recent electronics market are characterized by single-chip implementation and a reduction of the number of component parts thanks to the advanced integration of semiconductors. On the other hand, the progress of inactive components such as capacitors still remains within the framework of single-function components. It is therefore urgently required to compound their functions and reduce the number of such components.

Based on these precepts we have succeeded in developing and mass-producing the Proadlizer as an innovative decoupling device. It also features excellent noise cancellation functions due to its low impedance over a broad frequency range with large capacitance.

We have already started supplying some of our customers in 2005, and customer approval is increasing daily with regard to its suitability for application in digital systems, etc.

This device is highly approved for its innovativeness and high performance, and has already been selected as one of the Ten New Products (FY2003) of The Nikkankogyo Shimbun Ltd., Excellent Prize of the First Monodzukuri Nippon Grand Award of the Japanese Ministry of Economy, Trade and Industry, and the 53rd Award for Promotion for Electrical Science and Engineering (OHM Technology Award).

This paper describes the features, construction, characteristics, mass-production methods, series production and reliability of the Proadlizer as it enters the mass-production phase in order to meet market demand.

## 2. Features of the Proadlizer

The Proadlizer is a device with a transmission line structure featuring high capacitance at a similar level to conductive polymer capacitors, low ESR (Equivalent Series Resistance) and an ESL (Equivalent Series Inductance) that is below 1/100 of ceramic capacitors. It has low impedance and a flat frequency response across the broad frequency range of from 100kHz to a few GHz. These excellent characteristics have made it possible to build a decoupling circuit with a few Proadlizer devices in place of the traditional method combining a larger assortment of capacitors, thereby allowing simplification of the circuit design and a significant reduction in the number of component parts. In an actually fabricated server system, we replaced 87 ceramic capacitors with 6 Proadlizers and confirmed that the CPU functioned without any problems.

These features allowed us to apply the Proadlizer device in NEC's notebook PCs such as “VersaPro UltraLite” and “LaVie” (**Photo 1** and **Photo 2**).

In these applications, we replaced some tens of capacitors including multilayer ceramic and aluminum electrolytic



Photo 1 External view of NEC notebook PCs.

## Development and Mass-Production of the New “Proadlizer” Decoupling Device

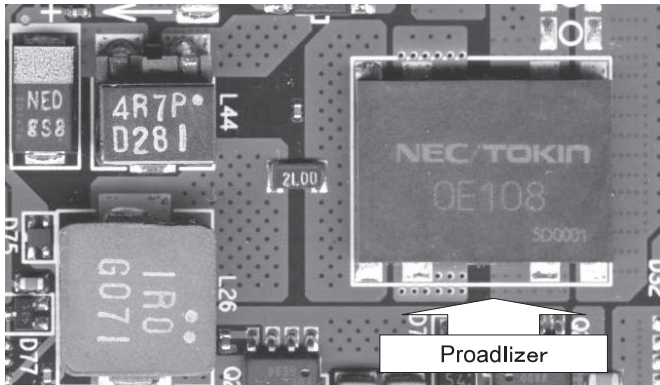

Photo 2 An application example of the Proadlizer.

capacitors with a single Proadlizer and succeeded in maintaining the CPU supply voltage variations at a similar or better level than before.

### 3. Construction of the Proadlizer

Now let us describe the fabrication procedures of the Proadlizer and provide an outline of its structure. We etched both sides of an aluminum foil, formed dielectric films chemically onto it for use as the anode and then deposited conductive polymer layers onto the chemically altered foil for use as the solid electrolyte. In addition we also formed graphite and silver paste layers in sequence to obtain a single-layered, 3-terminal aluminum electrolytic capacitor element.

We then layered the required number of elements for the desired static capacitance by connecting copper alloy pieces, called the spacers to the cathodes of the elements using an ultrasonic welding technique. A multilayer structure composed of stacked multiple single-layer elements was fabricated by connecting their anodes by laser welding and the cathode planes and sides by conductive pasting.

The outer case of the device is fabricated by insertion molding of thermoplastic resin onto the lead frame that consists of three terminals for anode-cathode-anode. The multilayer body inside the case and the anodes and cathodes of the elements are connected to the external terminals on the lead frame using conductive paste and the outer cover is attached around the case using epoxy adhesive agent (Photo 3, Fig. 1).

The use of aluminum with its well known dielectric properties has made it possible to design the device with a high capacitance, high reliability and at reduced cost. The outside case construction method helps to significantly reduce the thermal stressing of the reflow packaging and the insertion molding

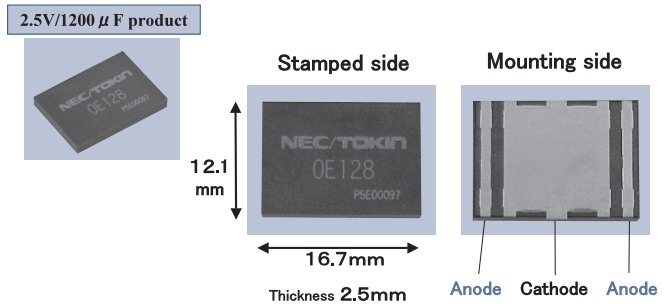

Photo 3 External view of Proadlizer.

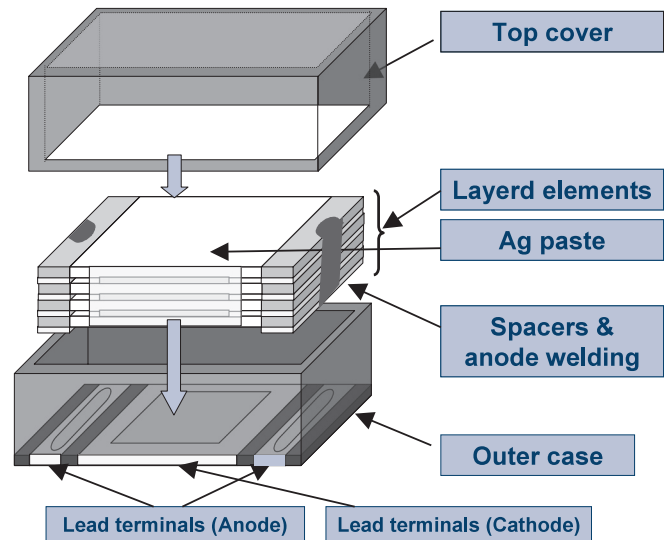

Fig. 1 Construction of the Proadlizer type F (Layered product).

has made it possible to improve the accuracy of the terminal design.

### 4. Characteristics of the Proadlizer

The flat, low impedance over a broad frequency band of the Proadlizer is the fruit of its core technology, which includes the polymer capacitor material technology (high capacitance, low ESR), the transmission line structure based on the high-frequency theory (low ESL) and the high-reliability design technology developed for the NeoCapacitor (high thermal resistance).

Fig. 2 shows the impedance (vs. frequency) characteristic of the Proadlizer in comparison with the aluminum electrolytic, tantalum and multilayer ceramic capacitors. Capacitors other than the Proadlizer present V-shaped impedance characteris-

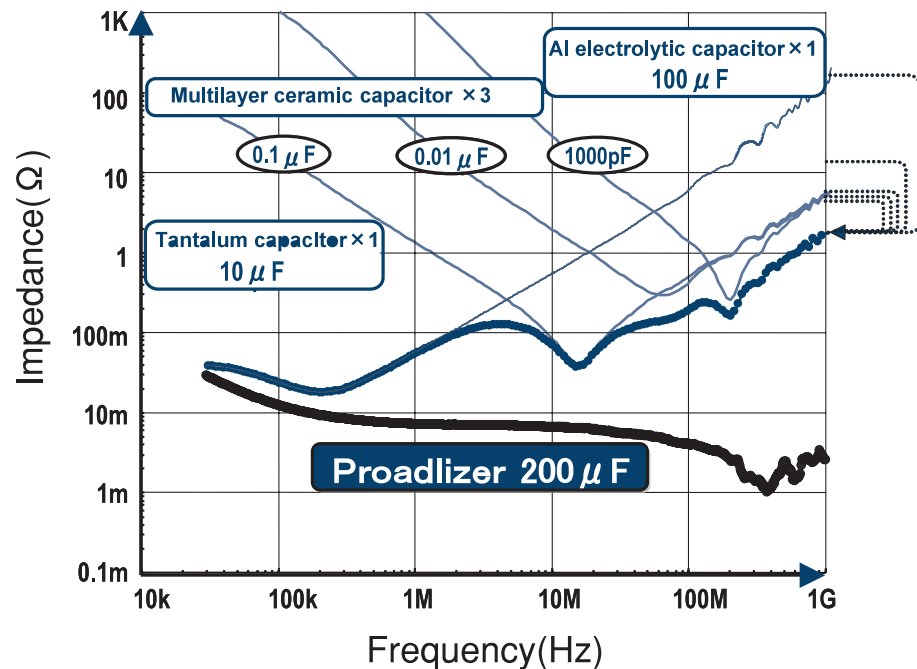

Fig. 2 Impedance-frequency characteristic of Proadlizer.

tics, which indicate that the frequency bands with low impedances are limited in the proximity of their self-resonant frequencies.

As a result, in order to build a decoupling circuit that needs to have low impedance over a broad frequency range, it has been necessary to combine a large number of capacitors with various self-resonant frequencies.

For reference, Fig. 2 shows the results of the calculations of synthetic impedance obtained by the parallel connection of a total of five capacitors of various types. It shows that the Proadlizer can offer much lower impedance and flatter frequency response compared even with the synthetic impedance. This result indicates that the decoupling and noise absorption performances of the Proadlizer are better than for the traditional combination of dissimilar capacitors.

## 5. Mass-Production of the Proadlizer

The mass-production of the Proadlizer is the resulting solution of a large number of problems. Among them, this section focuses on the reduction of ESR (100kHz), layered welding of anodes and creasing of the solder fillets all of which posed high level challenges.

### 5.1 ESR Reduction

Low impedance can be achieved by reducing both the ESL at the high-frequency band and the ESR. We succeeded in reducing the ESR as described below.

When four elements are layered to form the Proadlizer, the elements are connected in parallel so that the ESR (100kHz) value of the four-layer device should theoretically be 1/4 of the ESR value of each element. However, with the four-layer Proadlizer devices in the initial period of mass-production, the average ESR (100kHz) value has been about 1/2 of the single-layer capacitor while the target value was below 1/3 as shown in Fig. 3.

This gap was attributed to the condition of the connection of the layering of the elements in contrast with the condition of the connection between the layered elements and terminals and also to the inherent resistance of the materials. The Proadlizer is fabricated by layering the elements upwards from the external terminals as described in Section 3 above. The point in achieving the theoretically calculated target value is thus how to connect the elements from the lowest to the highest layers with low impedance or how to reduce the resistance of parallel-connected elements to as low a level as possible.

Based on the above considerations we estimated that it would

## Development and Mass-Production of the New “Proadlizer” Decoupling Device

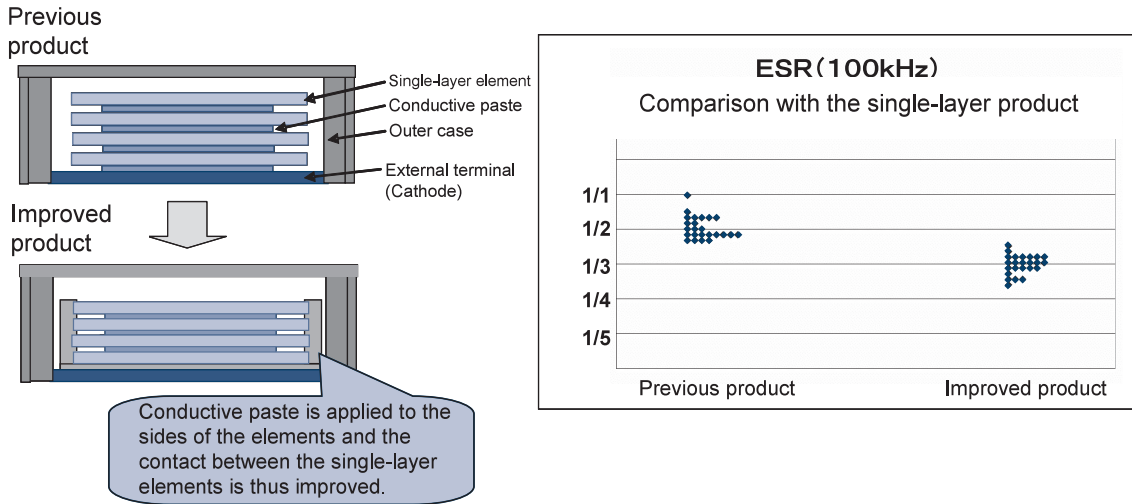

Fig. 3 Improvement of ESR (100kHz).

be effective to reserve a current path with a large cross-section from the external terminals to the highest-layer element in order to reduce the total resistance between them.

We therefore decided to apply conductive paste to the sides of the cathode while the layered elements have been connected by applying conductive paste only to the cathode planes. We also reviewed the production conditions for improving the contact from the external terminals to the highest elements.

As a result, we acquired our current mass-production capability by reducing the ESR (100kHz) value of the four-layer device to the target value of about 1/3 of a single-layer capacitor as shown in Fig. 3.

### 5.2 Multilayer Anode Welding

The Proadlizer features multilayer construction, therefore the selection of the method of connection of the layered elements is one of the key issues for its product reliability. This section deals with the connection method of the anodes.

We connected the anodes of the layered internal elements by welding. Among the several options for the welding technique are resistance welding and laser welding, we selected laser welding in consideration of its connection strength, reliability and mass-production capability. The laser type options included CO<sub>2</sub>, YAG and excimer laser, we selected the YAG laser for its laser power, melting point of the welded material, laser wavelength, welding area and its ease of incorporation in the automated machine. As the Proadlizer with a 3-terminal construction has two anodes and thus two welding points, the YAG

laser is optimum because its laser beam can be diverged by the fibers as well as from the viewpoints of mass production capability and equipment costs.

**Photo 4(a)** shows the view before laser welding and **Photo 4(b)** shows the view after the completion of welding. The aluminum materials of the internal element anodes as well as the spacers of the elements are completely melted in the laser welding process and a stable weld is obtained without any sputtering etc.

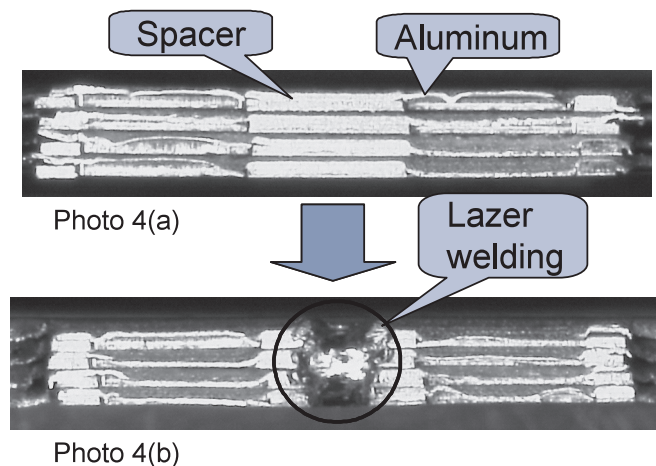

Photo 4 SEM of laser welding cross-section.

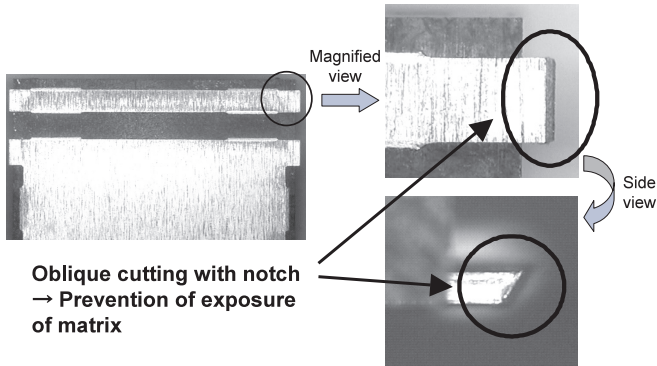

Photo 5 External view of the cut section of external terminal.

### 5.3 Solder Fillets

Most customers of surface-mounted type chip components request formation of solder fillets on the terminals in order to confirm the solder attaching condition around the terminals after component mounting. Since the Proadlizer is also a surface-mounted type component we provide it with solder fillets by applying the solder cutting method.

A component that has electrodes on its bottom surface such as the Proadlizer, generally has the solder fillet formed by plating the cut surface of the external terminals after fabrication or by providing the cut section with holes or embossing in advance. However, since these techniques would increase the fabrication cost, we decided to mark notch positions on the external terminals and then cut the notches (Photo 5). This method makes it possible to leave plating on the notches and also to minimize the cutting cross-section without plating, so that solder fillets can be created after component mounting due to the creeping-up of the solder (Photo 6).

We had already established the Proadlizer mass-production system with a 6-million/month production capability at our domestic plants by March 2006. We are presently enhancing the 4-million/month production capability in the overseas plants in order to eventually create a 10-million/month production capability.

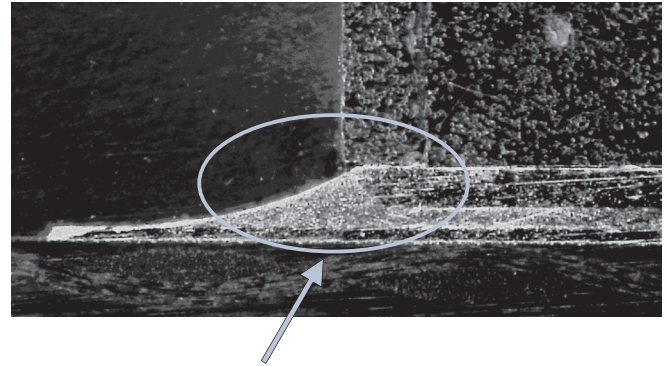

Solder comes in the notch cut section to form an adequate fillet.

Photo 6 Created solder fillets on the cut section.

## 6. Series Production (Product Lineup)

The currently mass-produced Proadlizer models are the 2.5V/1000 $\mu$ F and 2.5V/1200 $\mu$ F models and the 2.5V/1500 $\mu$ F model is under development. To make all of these models compatible with the low voltage, high frequency and large current required for the latest semiconductor chips, we are advancing a further reduction of impedance at high frequencies and an increase in the capacitance (Table).

## 7. High-Temperature Reliability

Since the Proadlizer is designed as a decoupling capacitor to be used with a CPU, it is necessary to verify its reliability with regard to any rise in temperature associated with the CPU.

Fig. 4 shows reliability data against high-temperature load (105°C, 2.5V application). It also indicates that reliability is not noticeably deteriorated for up 1,000 hours in a high-temperature atmosphere of 105°C. However, we will continue improvements of both the production process and choice of materials in order to improve its performance.

Table Proadlizer product lineup.

Model	Dimensions (mm)	Rated Voltage(V)	Static Capacitance ( $\mu$ F)	Status
PFAF250E108M	16.7 × 12.1 × 2.5	2.5	1,000	Under mass-production
PFAF250E128M	16.7 × 12.1 × 2.5	2.5	1,200	Under mass-production
PFAF250E158M	16.7 × 12.1 × 2.5	2.5	1,500	Under development

## Development and Mass-Production of the New “Proadlizer” Decoupling Device

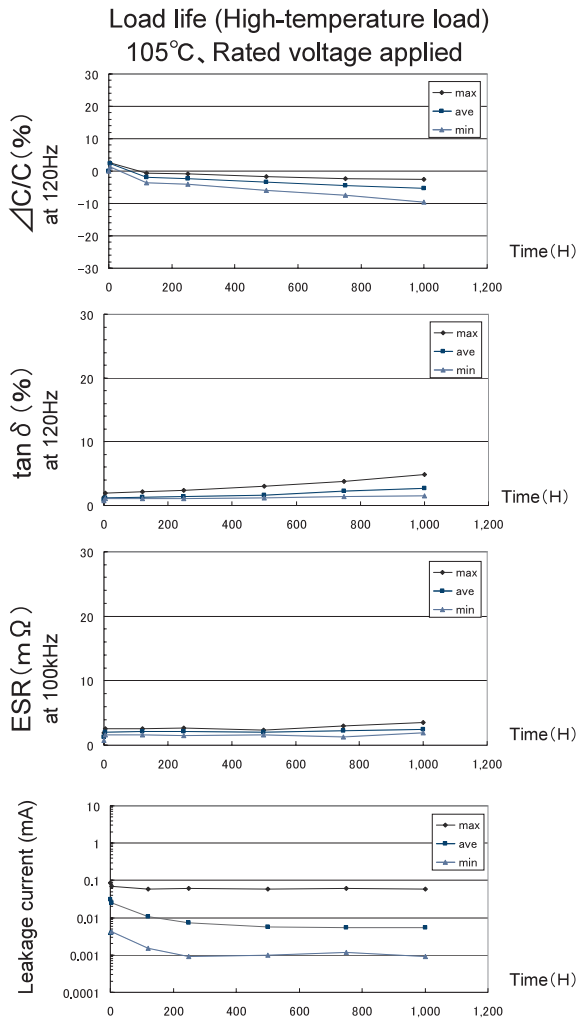

Fig. 4 Reliability test results.

## 8. Conclusion

The Proadlizer is an epoch-making new device that may be used as a decoupling device for much digital equipment. The advantage of the device has already been approved in the market and the supply to certain customers has already been started. In order to expand the market in the future, it will be essential to expand the product range by decreasing the size and increasing the capacitance as well as by reducing the cost.

We intend to make the Proadlizer a world-first global standard for IPCs (Integrated Passive Components). In the future, it will also be our intention to make every effort to further the

development and mass-production methods by aiming at a timely release of products featuring high performances and low costs.

### References

- 1) Arai, T., Takahashi, M., Toida, T., and Inoi, T.: “DENSO SENRO KOZO NO SHIN-Decoupling Device NO KAIHATSU TO SONO Application (Development of New Decoupling Device with Line Transmission Structure, Its Applications),” NEC TOKIN Technical Review, Vol. 30, 2003, pp14-20.
- 2) Arai, T., Tsubota, K., Inoi, T., and Hori, H.: “DENSO SENRO KOZO Device Proadlizer™ NO NOOTO PC ENO APURIKEESHON (Application of Transmission Line Structure Device “Proadlizer™” to Notebook PCs),” NEC TOKIN Technical Review, Vol. 32, 2005, pp91-96.

### Authors' Profiles

**TAKAHASHI Kenichi**  
Staff,  
Product Engineering Dept.,  
Capacitor Division,  
NEC TOKIN Corporation

**INOUE Takeo**  
Staff,  
CS Quality Promotion Dept.,  
Capacitor Division,  
NEC TOKIN Corporation

**NAGASAWA Toshihisa**  
Manager,  
Product Engineering Dept.,  
Capacitor Division,  
NEC TOKIN Corporation

**SEKIGUCHI Yoshinori**  
Manager,  
CS Quality Promotion Dept.,  
Capacitor Division,  
NEC TOKIN Corporation